

Operation Manual

Free Chlorine Controller

FCL5000/ FCL5500

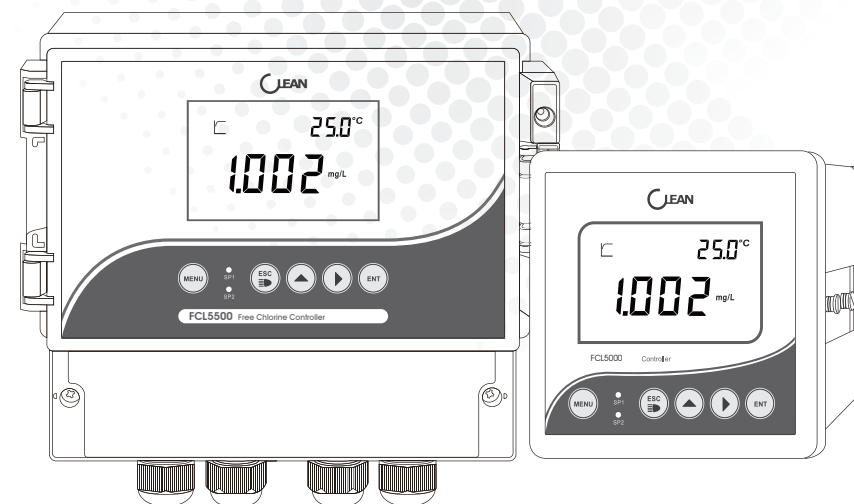

FCL5000/FCL5500 Free Chlorine Controller

www.cleaninst.com
Customer Service: CS@cleaninst.com

CLEAN INSTRUMENTS
2006, No.511 Tianmu W. Rd. Shanghai 200070, China
2F No.140, Zhongxiao St., Zhonghe Dist., New Taipei City ,Taiwan



www.cleaninst.com

TABLE OF CONTENTS

1 PREFACE	01
1.1 Before Use	01
1.2 In Use	01
1.3 Safety	01
2 PRODUCT OVERVIEW	02
2.1 Product Features	02
2.2 Technical Specifications	03
2.3 Appearance	04
2.3.1 Display	04
2.3.2 Display Character Table	04
2.3.3 Key Panel	05
2.3.4 LED Indicator	05
2.4 Menu Preview	06
3 INSTALLATION	07
3.1 Installation	07
3.2 Connection Diagram	09
4 CALIBRATION	10
4.1 pH Calibration	10
4.2 Free Chlorine Calibration	11
5 pH SET UP	12
P-01 Free Chlorine or Hypochlorous Acid(HCLO)	12
P-02 Measurement Range	13
P03 pH Compensation	13
P04 Standard Solution	14
P05 Temperature	15
P06 Relay 1/ P07 Relay 2	16
P08 Relay 3	17
P09 Current Output	18
P10 RS-485 output	19
P11 Password	20
P12 Factory Defaults	20
6 Parameter Review	21
7 APPENDIX	22
8 PROTOCOL	23
9 GENERAL INFORMATION	28
9.1 Warranty	28
9.2 Return Of Malfunction Instruments	28
9.3 Guidelines Or Returning Unit For Repair	28

1 PREFACE

1.1 Before Use

Thank you for selecting CLEAN Controller/Transmitter.

Although the Controller / Transmitter use advanced technology and meet the requirements of current safety rules, improper use can still threaten the safety of users, and / or cause harmful influences to factory and other equipments. Therefore, before using the controller / transmitter, relevant person must read and understand contents of this operation manual.

Operation manual should be kept accessible within the person who use the controllers / transmitters.

If you have problems which are not mentioned or can not be explained in this manual, please contact CLEAN local customer service center. They will be very glad to help you.

1.2 In Use

On any unmentioned use or the use that contradict with the technical parameters the operators should bear the responsibility.

Other conditions of right use include:

- Remarks and requirements stated in operation manual.
- Local safety regulations on safe operation.
- Information and warning of products that are used together with the transmitters in the contract. (chassis, electrode, etc.)
- Required operating environment and working condition.

1.3 Safety



The transmitters may only be carried out by trained experts.

Unqualified Transmitters should not be installed and used.

The transmitters should be used under the required working condition.

The transmitters should not be opened and repaired by clients themselves.

Modified transmitters should not be used. Manufacturers and suppliers do not bear responsibility for the damage and lost caused by modifying instruments without permission. Clients should bear all the risks.

This instrument is IP65 rated. Please use waterproof cable glands when you connect the cable. Also, please loose it when you open the cover. After connecting the cable, please tighten the cable conductor according to the following instruction with cable ties, or it will cause danger such as cable conductor or interface falls off when open the cover.



Please make sure to cut the power off when you open the cover to carry on any operation.

2 PRODUCT OVERVIEW

2.1 Product Features

This is a microprocessor based analyzer. The purpose of this analyzer is designed to analyze and control the free chlorine value (residual chlorine), hypochlorous acid value (HClO) and the temperature continuously and accurately.

This transmitter has many user-friendly and safety features which include:

- Double high impedance input .
- IP65 rated, waterproof and anti-gas, applicable in extreme conditions.
- High protection against electromagnetic interference.
- Menu-driven program that simplifies set-up.
- Built-in memory backup to ensure that setup parameter and calibration information are not erased in power-off condition.
- Scalable isolated 4-20mA Outputs
- Temperature value offset adjustment.
- LED indicators monitor control status from a distance.
- Large LCD, with high luminance LED backlight.

2.2 Technical Specifications

Model		FCL5000	FCL5500
pH	Range	2.00 ~ 12.00pH	
	Resolution	0.01pH	
	Accuracy	±0.01pH	
Free Chlorine / Hypochlorous acid	Range	0 ~ 2.000mg/L or 0 ~ 20.00mg/L	
	pH compensation	2.00 ~ 9.00pH	
	Resolution	0.001mg/L or 0.01mg/L	
Temperature	Accuracy	1% ± 1LSD	
	Range	-10.0 ~ 110.0 °C	
	Resolution	0.1 °C	
Signal Output	Accuracy	±0.3 °C	
	Temperature Sensor	NTC22K / PT1000	
	Temp. Compensation	Automatic -5.0 - +100 °C	
	Signal Output	4-20 mA (Adjustable)	
Data interface	Current Accuracy	1% F.S.	
	Load	< 500 Ω	
	RS485	Yes	
Relay Output	On/Off	2 SPST Relays	
	Output	2.5A 230 VAC	
	Cleaning/Alarm Relays	1X 2.5A	
Others	Power	85 ~ 260 VAC or 24 VDC	
	Working Temperature	0 ~ 60 °C	
	Humidity	< 90%	
	IP Rated	IP65	
	Installation	Panel Mounting	Wall Mounting
	Dimensions	(H×W×D) 108×108×158 mm	160×188×108 mm
	Panel Cut Size	94.5×94.5 mm	—
	Weight	0.6 kg	0.7 kg

2.3 Appearance

2.3.1 Display

- 1 Measuring Status-Calculating
- 2 Measuring Status-Stable Value
- 3 Electrode inserted display
- 4 Setup display
- 5 **Offset** - Electrode Offset
- 6 **Slope** - Electrode Slope
- 7 **Done** - Calibration Done
- 8 **mg/L, PH, mA, °C, %** - Unit of Measurement
- 9 **Auto / Manual** - Temperature Compensation
- 10 **4.01, 7.00, 10.01** Calibrated Points -USA Buffer Standard
- 11 **4.01, 6.86, 9.18** Calibrated Points - NIST Buffer Standard

Note: In measurement mode, if the segment icon "9.18" twinkling, it means the pH value is over pH 9, beyond the normal scope of compensation.

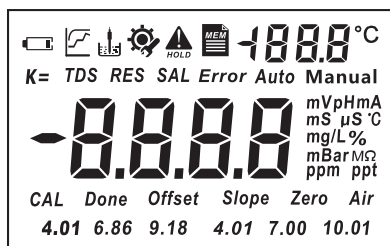

2.3.2 Display Character Table

FCL	Free Chlorine	Slope	Electrode Slope
CAL	Calibration	HCL0	Hypochloric acid
SEN	Sensor	PH	PH value
TYPE	type	Offset	Sensor Offset
RNG	Measurement Range	P-	Menu item
PHC	pH Compensation	Code	Password Setting
BUF	Buffer Solution	DEF	Factory Defaults
NIST	NIST Standard	SL1	Sensor Slope 1
USA	USA Standard	SL2	Sensor Slope 2
TC	Temperature Compensation	SAVE	Save Data
Auto	Automatic Temperature Compensation	Err	Error
Manual	Manual Temperature Compensation	ON	On
H22	22K Sensor	OFF	Off
Pt	PT1000 Sensor	NO	No
TOFS	Temperature Offset	YES	Yes
RLY1	Relay 1	OUr	Temperature value Over
RLY2	Relay 2	Udr	Temperature value Under
RLY3	Relay 3	FULL	Full Data Storage
CURr	Current Output	OUEr	Measuring Value Over
485	Data output	UNdr	Measuring Value Under

2.3.3 Key Panel

Key	Description
	Menu Key In measuring status, press the key once into Calibration mode In calibration or Set up mode, Press the key back to measuring status
	Escape Key Press and back to previous screen display in Calibration or Set Up mode Back light on and off switch in measurement status
	Up Arrow Key In measuring status, press the key into "Set Up Status Review" mode, press again to check each set up status. In SET UP mode, press to select items and to adjust set value. In Menu mode, act as forward cycle key
	Right Arrow Key In measuring status, press the key to change measurement mode In SET UP mode, press to select digits of value In Menu mode, act as backward cycle key
	Confirm Key Confirm the selection

2.3.4 LED Indicator

LED Indicator

SP1/ SP2 LED light-on shows the relevant relay is in working status.

2.4 Menu Preview

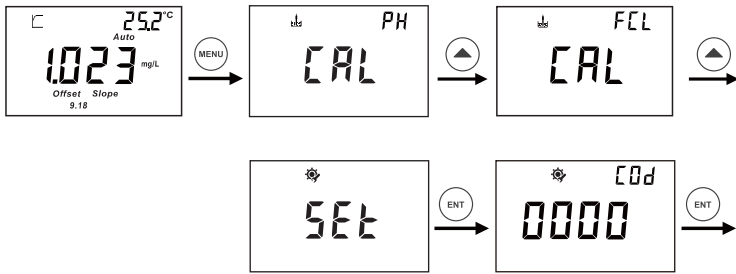

- In measurement mode, press **MENU** key to enter calibration step, and then, press **▲** key to enter set up process.
- Press **ENT** key to pass through, if you have not set up password.



P-01 Free Chlorine or Hypochlorous Acid(HClO)



P-02 Measurement Range



P-03 pH Compensation



P-04 Standard Solution

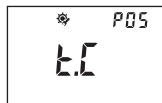

P-05 Temperature

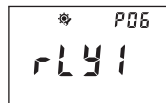

P-06 Relay 1

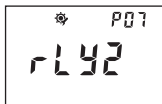

P-07 Relay 2

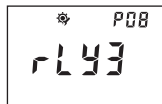

P-08 Relay 3



P-09 Current Output

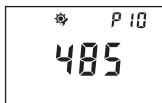

P-10 RS-485 output



P-11 Password



P-12 Factory Defaults

3 INSTALLATION

3.1 Installation

Panel Mounting

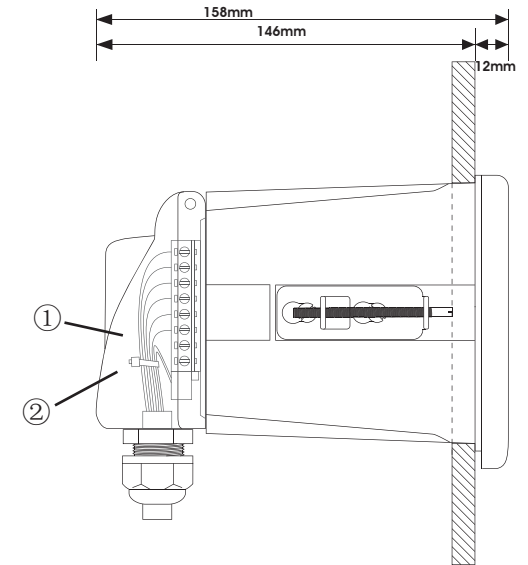

Panel cutout :
94.5 * 94.5mm (± 0.5 mm)
(panel-mounting)

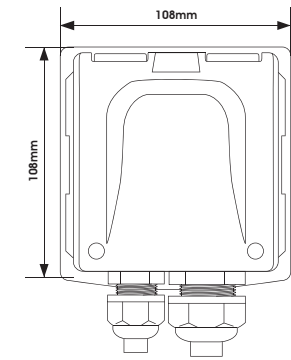
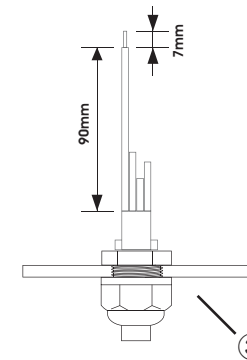

- ① Cable (Recommended stripping length for cables is at least 90mm, please use 0.5 to 1 square meter's wire)
- ② Cable ties
- ③ Waterproof cable glands

Wall Mounting

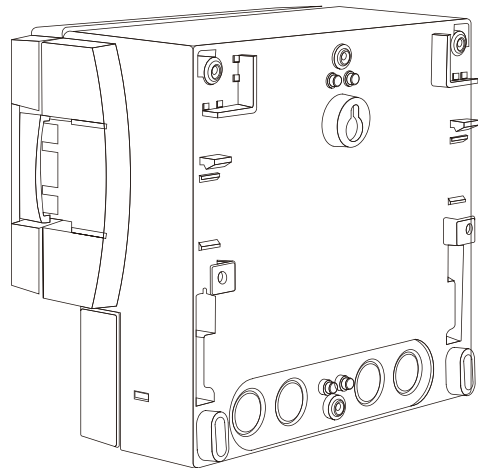
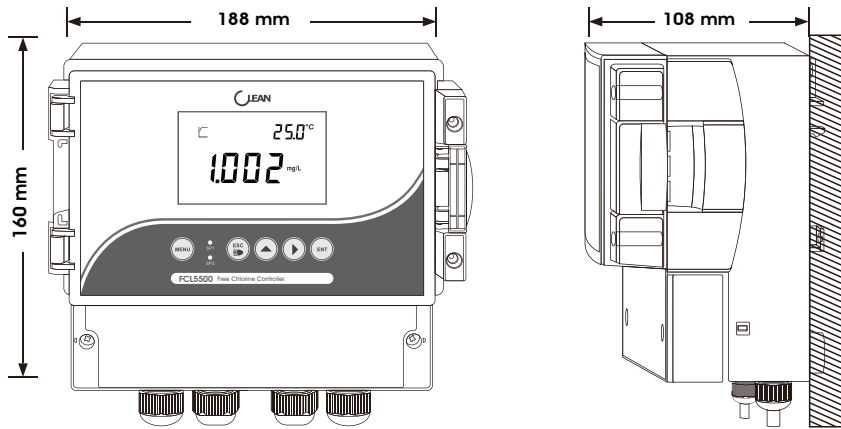

3.2 Connection Diagram

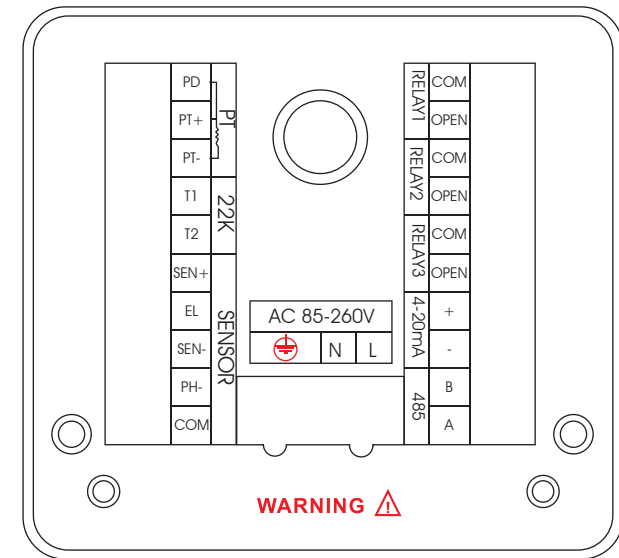

Terminal	Function	Terminal	Function
PD	Pt1000 drive positive	COM(RL2)	COM(RL2)
PT+	Pt1000 signal positive	OPEN(RL2)	OPEN(RL2)
PT-	Pt1000 signal negative	COM(RL3)	COM(RL3)
T1	T1	OPEN(RL3)	OPEN(RL3)
T2	T2	4-20mA (positive)	4-20mA output, positive
SEN+	FCL Work Electrode	4-20mA(negative)	4-20mA output, negative
EL	FCL Polarization Electrode	485(B)	485 output
SEN-	FCL Reference Electrode	485(A)	485 output
PH-		pH	pH/ORP input terminal
COM		L	Line
COM(RL1)	COM(RL1)	N	Neutral
OPEN(RL1)	OPEN(RL1)	⊕	Earth

Note:
For 2-wire Pt1000 temperature sensing terminal system, use short circuit between PD and PT+.
Connect Earth with SEN- when Earth pH sensor is required.

4 CALIBRATION

4.1 pH Calibration

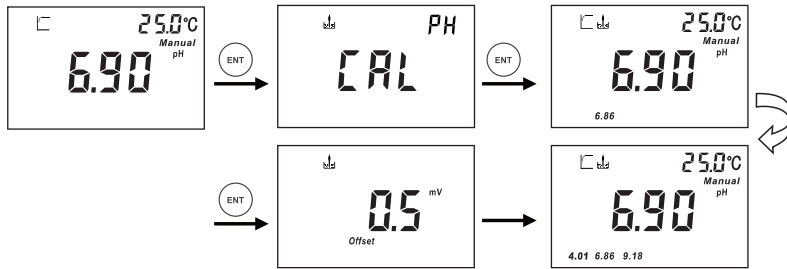

- In pH measurement mode, press **MENU** key to enter pH calibration step, and then, press **ENT** key to enter calibration process.
- Dip the sensor into 7.00 or 6.86 pH buffer solution first, you will soon get the zero point offset value from the screen.
- After point of 7.00 or 6.86 pH calibrated, you can go to next point calibration.



- To continue to calibrate second point (4.01, 10.1, or 9.18). When the value is stable, press **ENT** key to confirm the result. You will get slope value of sensor from the screen.
- You can go next to third point calibration or quit the calibration process.



- During the calibration process, you can press **ESC** key to terminate calibration process, or press **MENU** key to go back to measurement status.

4.2 Free Chlorine Calibration

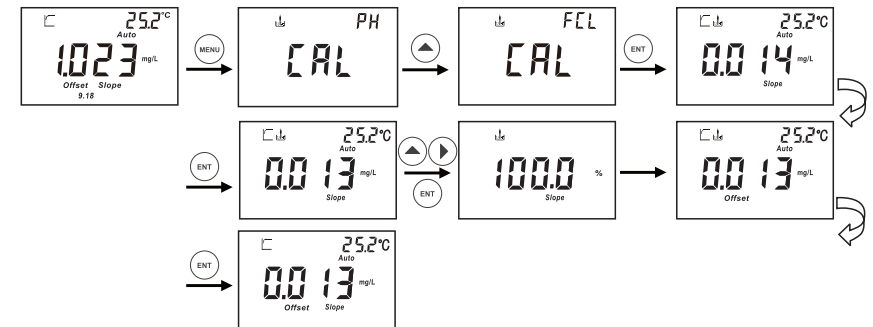

In measurement mode, press **MENU** key, **▲** key, and then **ENT** key to enter Free Chlorine calibration steps.

First point calibration:

-Dip the free chlorine sensor into known standard solution. When the stable segment icon "☐" shows up, press **▲▶** key to input the same concentration value as of the known standard solution, then, press **ENT** to confirm it.

It's recommended to use DPD method to measure your free chlorine water sample first, and then press **▲▶** key to enter the free chlorine value you got from DPD method, press **ENT** key to confirm it.

Zero point calibration:

After first point calibration, please dip the sensor into deionized water. When the reading value is 0.00 mg/L, press **ENT** to confirm it. The meter shows OFFSET and Slope value, then automatically back to measurement mode.

5 FCL SET UP

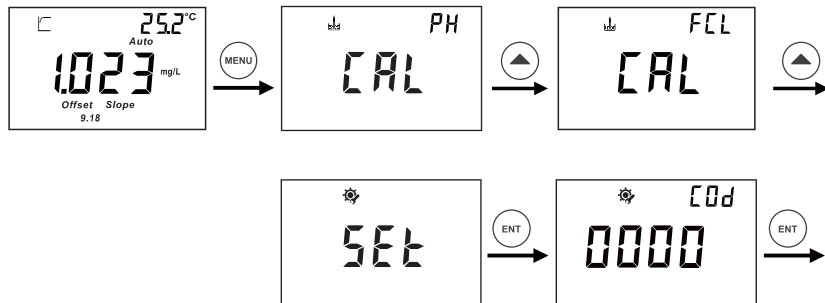

- In measurement mode, press **MENU** key to enter calibration step, and then, press **▲** key to enter set up process.
- Press **ENT** key to pass through, if you have not set up password.

P-01 Free Chlorine or Hypochlorous Acid (HClO)

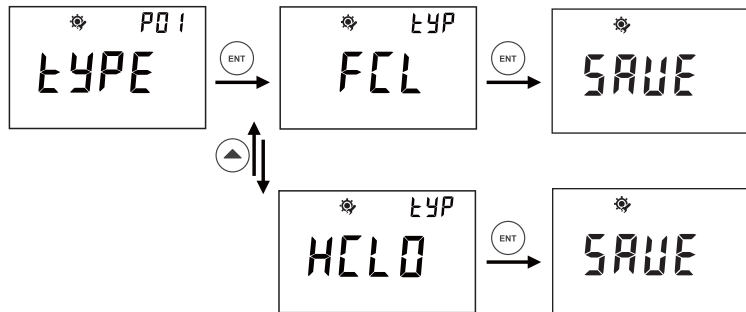

- - In P-01, you can select FCL (Free Chlorine) or Hypochlorous Acid mode
- - Please refer to above description steps to finish setting up P-01
- - You can go to next parameter setting by pressing **▲▶**, or press **MENU** key to quit and go back to measurement mode.
- Factory default: GLASS

P-02 Measurement Range

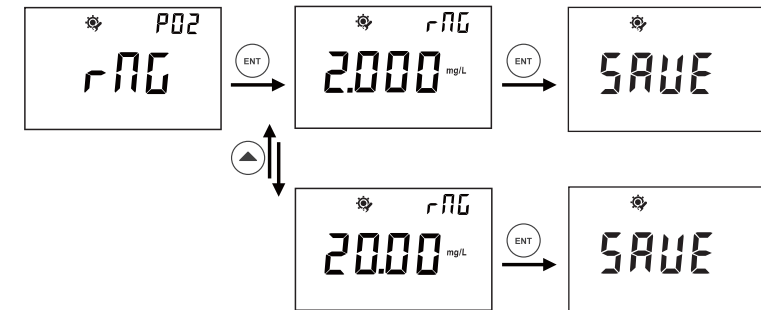

- - In P-02, you can select a measurement range, 0 to 2.000 mg/L or 0 to 20.00 mg/L, according to your needs.
- - Please refer to above description steps to finish setting up P-02
- - You can go to next parameter setting by pressing **▲▶**, or press **MENU** key to quit and go back to measurement mode.

P-03 pH Compensation

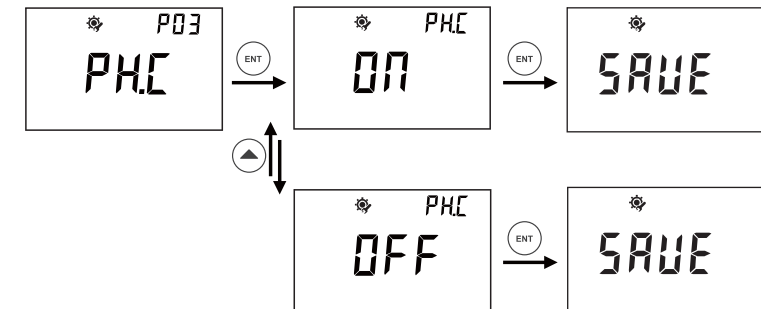

- - In P-03, you can select pH compensation function on or off. It's suggested to turn on pH compensation when you are measuring free chlorine value.
- - Please refer to above description steps to set up P-03

P04 pH Standard Solution

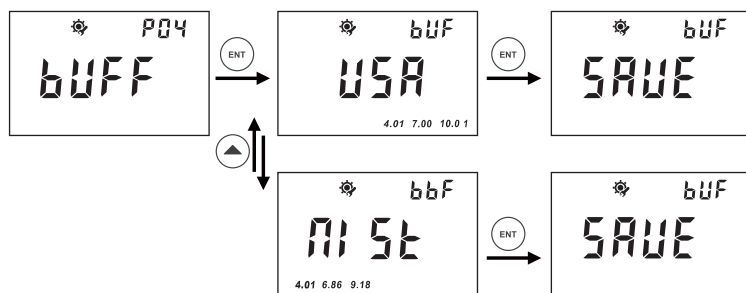

- In P-04, you can select a group of buffer solutions as a standard: USA (4.01, 7.00, 10.01) or NIST (4.01, 6.86, 9.18).
- Please refer to above description steps to setup P-02.
- You can go to next parameter setting by pressing **▲▶**, or press **MENU** key to quit and go back to measurement mode.
- Factory default: NIST

P05 Temperature

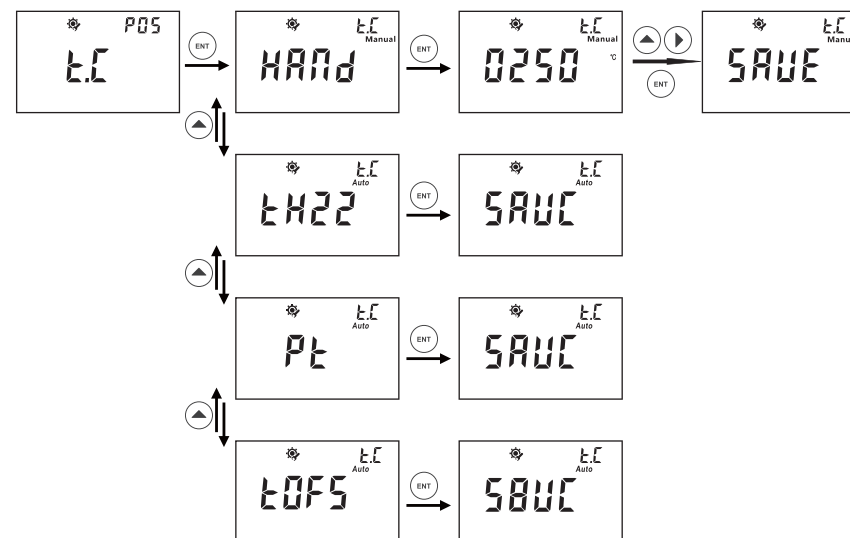

- In P-05, you can complete 3 temperature related settings:
 - 1, set up manual temperature compensation or automatic temperature compensation.
 - 2, set up temperature sensor type.
 - 3, set up temperature offset value.
- Please refer to above description steps to set up P-03.
- You can go to next parameter setting by pressing **▲▶**, or press **MENU** key to quit and go back to measurement mode.

P06 Relay 1 (SP1) / P07 Relay 2 (SP2)

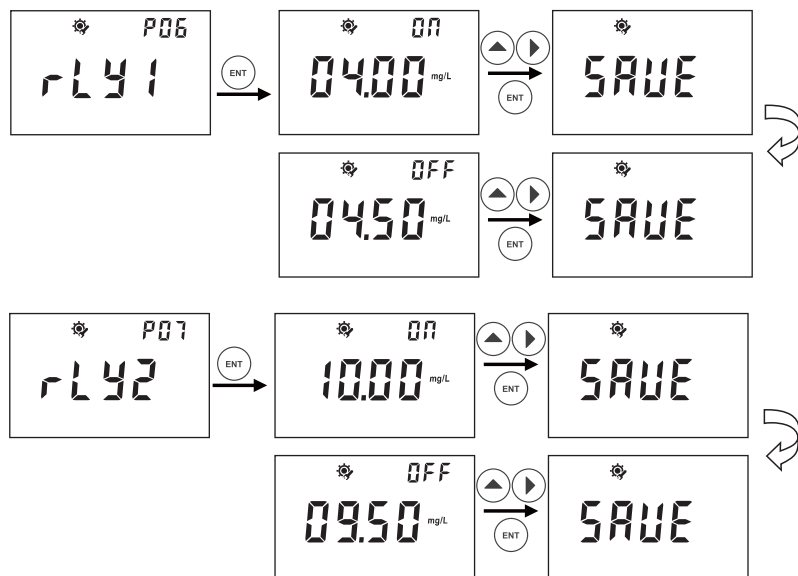

- In P-06, you can set up Relay 1 (SP1): ON-Point and OFF-Point.
- The range for setting up ON-Point and OFF-Point is from -2.00pH to 16.00pH.
- Please refer to above description steps to set up P-04.
- You can go to next parameter setting by pressing ▲▶, or press **MENU** key to quit and go back to measurement mode.
- P-05, the same procedure as P-07.

P08 Relay 3

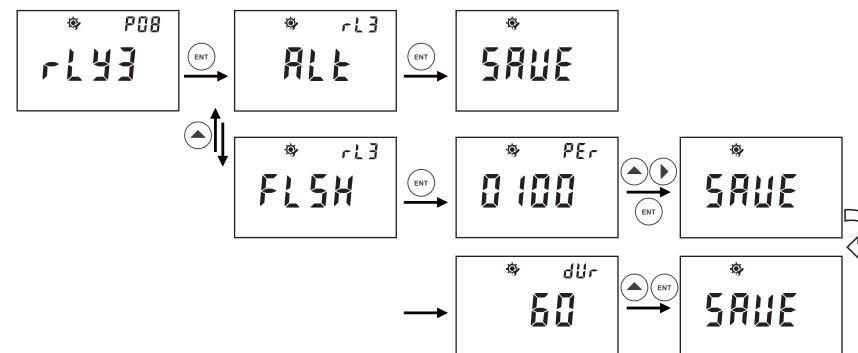

- In P-08, you can set up Relay 3 (rLY3), also called the Cleaning/Alarm Relay.
- After entering P-06, you can press ▲ to set the ALT and FLSH.
- By pressing **ENT** to set the ALT function, the unit will then alarm if the other two Relays have any operation.
- FLSH refers to the Cleaning function. The cleaning frequency can be set per each 0-1000hours and 0-120 seconds for the time of duration.
- You can press ▲▶ to set the specific hours you need to clean per each time. Press ▲ to set the duration time per each cleaning.
- Please refer to above description steps to set up P-06.

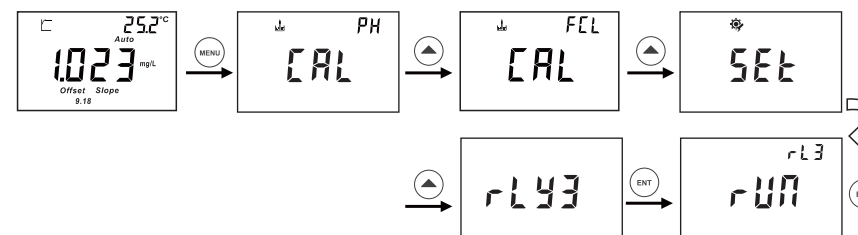

Note: The Cleaning/Alarm Relay can also be set as Manual in the measuring mode as below: After entering Relay 3 Manual setting, press **ENT** Key, the screen will twinkle and display "RUN". The twinkling will stop by pressing **ENT** and the unit starts to clean/alarm.

P09 Current Output

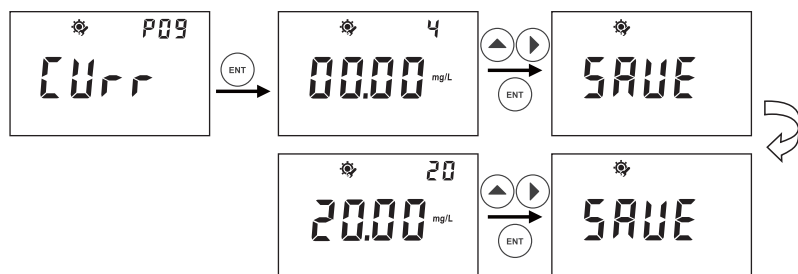

- In P-09, you can set up current output / transmitting for measurement valve for advanced application.
- After entering P-09, the figure 4 on top right corner represents transmitting 4 mA out for below set value (0.00pH), you can press ▲► to set a value you need to transmit 4 mA for your application.
- The figures 20 on top right corner represent transmitting 20 mA out for below set value (14.00pH).
- The pH range for setting is from -2.00 to 16.00pH.
- Please refer to above description steps to set up P-05
- You can go to next parameter setting by pressing ▲►, or press **MENU** key to quit and go back to measurement mode.

P10 RS-485 output

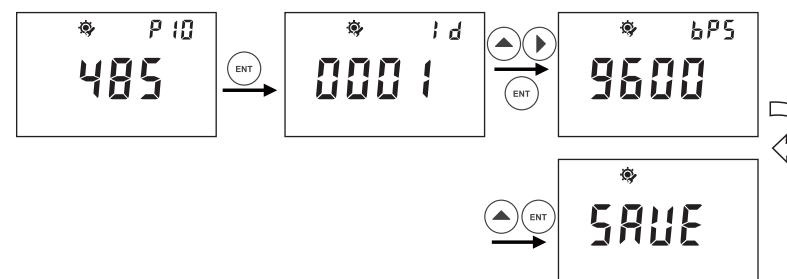

- After entering P-10, you can press ▲► to set the ID of the protocol address and press **ENT** to confirm. ID range can be set from 01 to 200.
- You can press ▲ to set the protocol rate you need and confirm by pressing **ENT**.

P11 Password

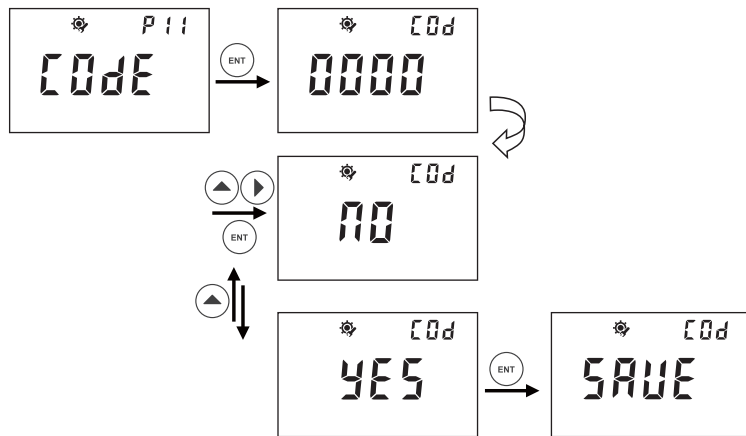

- In P-11, you can set up password method to prevent anyone from changing your settings.
- Please refer to above description steps to set up P-06
- You can go to next parameter setting by pressing **▲▶**, or press **MENU** key to quit and go back to measurement mode.
- Factory default: 0000

P12 Factory Defaults

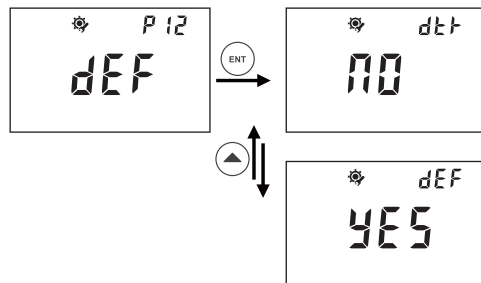

- In P-12, you can select to change factory defaults or to revert to factory default status.
- Please refer to above description steps to set up P-04
- You can go to next parameter setting by pressing **▲▶**, or press **MENU** key to quit and go back to measurement mode.

6 Parameter Review

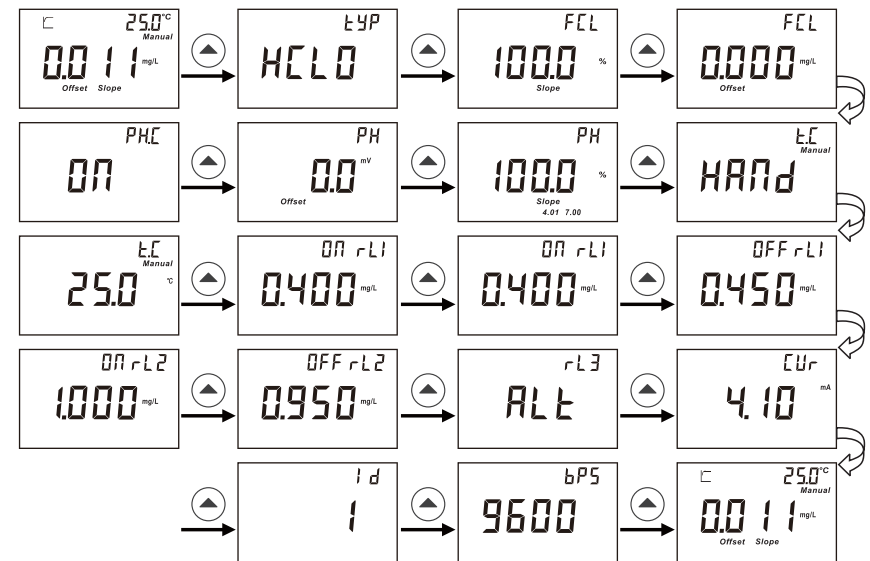

Press **▲** to check through all the Calibration parameters and Setting parameter in measurement mode.
Press **MENU** or **ESC** to quit and go back to measurement mode.

pH temperature Corresponding To pH Buffer Solution

Temperature (°C)	pH4.01	pH6.86	pH9.18	pH4.00	pH7.00	pH10.01
0	4.01	6.98	9.47	4.01	7.12	10.32
5	4.01	6.95	9.38	4.00	7.09	10.25
10	4.00	6.92	9.32	4.00	7.06	10.18
15	4.00	6.90	9.27	4.00	7.04	10.12
20	4.00	6.88	9.22	4.00	7.02	10.06
25	4.01	6.86	9.18	4.00	7.00	10.01
30	4.01	6.85	9.14	4.01	6.99	9.97
35	4.02	6.84	9.10	4.02	6.98	9.93
40	4.03	6.84	9.07	4.03	6.97	9.89
45	4.04	6.83	9.04	4.04	6.97	9.86
50	4.06	6.83	9.01	4.06	6.97	9.83
55	4.08	6.83	8.99	4.07	6.97	9.81
60	4.10	6.84	8.96	4.09	6.98	9.79
70	4.12	6.85	8.92	4.12	6.99	9.76
80	4.16	6.86	8.89	4.16	7.00	9.74
90	4.20	6.88	8.85	4.20	7.02	9.73

1. General Introduction

The unit adopts the RS-485 Modbus Protocol. The communication distance is as long as 1200m by merging 1-200 units in one communication line. Range of the ID code can be from 001-200.

Communication baud rate range 1200, 2400, 4800,9600,19200.

Data format can refer to the Modbus RTU format.

2. Composition of the communication command: Command from the Host computer

Console computer address(ID code)	Command code	Command object	CRC (Calibration)
1 byte	1 byte	1 byte	2 bytes(High order in front)

3. Console computer address and the unit (ID code of the Console computer)

Command code: 03 is fixed here to read the contents from the register

Command object: the data format of the Host computer need to read from

Command	Object	Explanation of the data
01	Floating data (measured data)	The measured data, include the output current and the status of the Relays
02	Calibration data	The zero point, slope, calibration point, etc of the electrode after the calibration done
03	Parameter setting 1	The public part of the setup data
04	Parameter setting 2	The exclusive part of different units

4. The complete command from the Host computer
(suppose the Console computer address is 01)

Console computer address	Command Code	Command Object	CRC Calibration	Explanation of the data
01	03	01	E1 30	reading the floating data
01	03	02	A1 31	reading the calibration data
01	03	03	60 F1	reading the parameter setting
01	03	04	21 33	reading the the parameter setting

5. Analyze on the error data from the Console computer

1) No responding from Console computer

- Wrong sending address from the Host computer
- Receive time out. Timing when the Console computer receives the first data. The receiving will stop if the received data is less than the required command bytes (5 bytes) when the second system is interrupted.
- Host computer command bytes exceeding. Command will be invalid if the received command bytes in the receiving time are more than required. If the command sending from the Host computer is too frequent also leads to the same problem. Suggest the interval of the Host computer command sending be more than 0.5 seconds.

2) Returned Error code from the Console computer

Returned Error code from the Console computer is 5 bytes. The command from the Host computer and the Error code share the same beginning of 8, for example:

Address	Host computer command +0X80	Error code	CRC calibration
1 byte	1 byte	1 byte	2 bytes

The Error code can be classified as the following 4 circumstances:

a. Error in command: The command from the Host computer is for example 01 05 01 E2 90 instead of 03.

The Console computer will return 01 05+80 81 82 F0

Command Error→01 85 81 82 F0

b. Error in Command objects. Available command object: 01. 02.03.04. If 01 03 07 61 32

the console computer will return: 01 03 +80 82 C1 51

Command object Error: 01 83 82 C1 51

c. Error in CRC calibration code: If 01 03 01 AA BB (correct code: 01 03 01 E1 30)

the console computer will return: 01 03 +80 83 00 91

CRC calibration code Error: 01 83 83 00 91

d. Unit not in the measurement condition, specially refers to when there is no mistake from the Host computer command, however, the Console computer is not in the correct measurement condition cause the failure of uploading the measurement results. For example:

Console computer returns: 01 03+80 80 40 90

Unit not in the measurement condition: 01 83 80 40 90

6. Analyze on the correct data from the Console computer

Note: The lower byte is behind the high byte in all returned integer data.

The returned data from the Console computer can also be classified in 4 circumstances as the Host computer.

1) Returned floating data: suppose the Unit ID code is 01

01	03	Number of data	Data	CRC value
Unit ID	Command	1 byte (fix the number of data as 15 here)	15 bytes data	The last 2 bytes

Analyze on the data:

01	03	Number of data	Data	CRC value
Unit ID	Command	1 byte (fix the number of data as 15 here)	15 bytes data	The last 2 bytes

Analyze on the data:

Byte	1、2	3	4
Analyze	Free Chlorine integer value	decimal point	unit

Note: Free chlorine and HClO integer value: 7FFF is over rang for free chlorine mode and HClO mode.

Decimal: 02 is two decimal, 03 is three decimal

Unit: 14 is mg/L

Byte	5、6	7	8
Analyze	The pH value integer	decimal point	unit

Note: 7FFF is outranged, 8000 is below is range.

Decimal point of the third byte: 02 is 2 decimal places, 00 is without decimal point

Unit of the fourth byte: 10 is pH、 00 is mV

Byte	9、10	11	12
Analyze	The temperature value integer	decimal point	unit

Temperature value: 7FFF is outranged, 8000 is below is range.

Byte 11: The decimal point of temperature 01 is a 1 decimal place.

Byte 12: 11 is °C、 12 is °F

Byte 9、 10、 11、 12 are reserved bytes.

Byte 13 and 14 are the current transmission output value (integer). The default is 2 decimal places, unit is mA.

Byte 15 is the status of the Relays, 0 is disconnect, 1 is closed. The first 5 figures are independent bits. The sixth figure is Relay 3、 the seventh figure is Relay2、 the eighth figure is Relay 1.

2) Returned Calibration data: suppose the ID code of the unit is 01

01	03	0F	Data	CRC value
Unit ID	Command	1 byte (fix the number of data as 15 here)	15 bytes data	The last 2 bytes

The definition of data part:

Calibration status of Byte 1:

pH: the first 3 figures are independent bits. The forth figure is the high point; fifth is the middle point and sixth is the low point. The last 2 figure are independent bits.

0 refers to without calibration、 1 refers to calibration done.

Byte 2 and 3 is the offset integer of pH. Default the unit of 1 decimal point is mV

Byte 4 and 5 are the acid slope- Byte 6 and 7 are the alkalinity slope.

Byte 8 for free chlorine sensor calibration status

0 is no calibration, 1 is one point calibration done, 2 two points calibration done(including zero point)

Byte 9, 10, is free chlorine offset integer value, one decimal default and unit is mg/L

Byte 11,12 is free chlorine slope

Byte 13、14、15 are reserved bytes.

3) Returned setting data, suppose the unit ID code is 01

01	03	XX	Data	CRC value
Unit ID code	Command	Number of data 1 byte (28 bytes)	28 bytes	The last 2 bytes

The definition of data part:

Relay 1:

1、 2	3	4	5、 6	7	8
ON integer	Decimal point	unit	OFF interger	Decimal point	unit

Relay 2:

9、 10	11	12	13、 14	15	16
ON integer	Decimal point	unit	OFF interger	Decimal point	unit

Relay 3:

17	18	19、 20
Relay type	Cleaning second(s)	Cleaning interval(hours) 2bytes integer

Relay 3:

21、 22	23	24	25、 26	27	28
The transmitter 4mA corresponding value (2bytes integer)	Decimal point	unit	The 20mA corresponding value(2bytes integer)	Decimal point	unit

4) Returned setting data, suppose the unit ID code is 01

01	03	XX	Data	CRC value
Unit ID	Command	Number of the data		The last 2 bytes

Analyze on the data part:

Byte	1	2	3
Analyze	Unit type: 4 is for Free Chlorine	Parameter: 0 is free chlorine, 1 is HClO	Range: 0 is 2.00 mg/L; 1 is 20.00 mg/L
Byte	4	5	
Analyze	pH compensation: 0 is ON 1 is OFF	pH Standard solution: 0 is USA; 1 is NIST	
Byte	6	7、 8	
Analyze	Temperature compensation type: 0 is Manual、 1 is TH22、 2 is PT1000	Manual temperature setting value or temperature offset value (Default 1 decimal point for 2 bytes integer, unit is °C)	

Unit comparison table

Data	0	1	2	3	4	5	6
Unit	mV	nA	uA	mA	Ω	KΩ	MΩ
Data	7	8	9	10	11	12	13
Unit	uS	mS	S	PH	°C	°F	Ug/L
Data	14	15	16	17	18	19	20
Unit	mg/L	g/L	ppb	ppm	ppt	%	mbar
Data	21	22					
Unit	bar	mmHg					

9 GENERAL INFORMATION

9.1 Warranty

CLEAN Instruments warrants this product to be free from significant deviations in material and workmanship for a period of one year from the date of purchase. If repair is necessary and has not been the result of abuse or misuse within the warranty period, please return to CLEAN Instruments and amendment will be made without any charge. CLEAN Instruments Customer Service Center will determine if product problem is due to deviations or customer abuse. Out of warranty products will be repaired on a charge basis.

9.2 Return Of Malfunction Instruments

Authorization must be obtained from CLEAN Instruments Customer Service Center to issue a RIR number before returning items for any reason. When applying for authorization, please include date requiring the reason of return. Instruments must be carefully packed to prevent damage in shipment and insured against possible damage or loss. CLEAN Instruments will not be responsible for any damage resulting from careless or insufficient packing.

Warning: Damage as a result of inadequate packaging is the User / distributor's responsibility. Please follow the guidelines below before transporting.

9.3 Guidelines Or Returning Unit For Repair

Use the original packaging material if possible, when transporting back the unit for repair. Otherwise wrap it with bubble pack and use a corrugated box for better protection. Include a brief description of any faults suspected for the convenience of Customer Service Center, if possible. If there are any questions, feel free to contact our Customer Service Center or distributors.